



OWNERS MANUAL & INSTALLATION GUIDE



CARBON ONLY



Scan code for more
information, troubleshooting,
and installation videos

HALO Water Systems Best Practices

Tips to Help You Get The Best Results

Congratulations on the purchase of your new HALO

The following information and list of “tips” was designed to help you better understand and maximize the effectiveness of this advanced water treatment technology.

Understanding and Appreciating Aragonite:

In appliances, on dishes and on countertops where water is frequently left standing, you may begin to notice a powdered talc-like substance collecting. This powder is called Aragonite. Aragonite is a harmless, electrically neutral and non-corrosive form of calcite that is produced during the magnetic conditioning water treatment process. Prior to passing through the ION magnetic conditioner, this Aragonite is actually the minerals that would have caused limescale build-up and corrosion in your pipes and appliances. The Aragonite is a byproduct formed after hard water passes through the ION magnetic conditioner and it is easily wiped off most surfaces. You should consider Aragonite as welcome proof that your ION conditioner is operating effectively.

Simple Actions to Help Minimize Aragonite on Dishes.

- 💧 Use ONLY powdered dishwasher soap.
- 💧 CUT DOWN ON SOAP. Use only 1 Tablespoon TOTAL divided one half tablespoon into each dispenser cup. Too much soap may cause spotting, etching, filming and/or glazing.
- 💧 Dishwasher hot water temperature should be at least 140° and hotter is better so, prior to starting your dishwasher, you should run the HOT water at the kitchen sink until it begins to flow hot. This ensures hot water for the dishwasher’s wash cycle.
- 💧 Use (as directed) a rinse agent such as “Lemi Shine”. Available at most Target, WalMart stores and Amazon.com.
- 💧 Turn off the dishwasher heating element and allow the dishes to cool dry. Open the dishwasher door slightly to allow steam to escape as soon as the wash cycle is complete.
- 💧 Always store detergent in a dry place as moisture adversely affects dish detergent contributing to spotting. Purchasing small boxes of detergent, may make it easier to keep fresh product on hand. Check the expiration date for freshness because dish detergent actually does expire!

Tips to Remove & Prevent Limescale Film on:

Dishes, glasses, small appliances & plumbing fixtures that have been subjected to untreated water prior to the installation of your HALO System; ***these items likely have soap scum and limescale build up.***

- 💧 Place affected dishes into dishwasher and run a complete wash cycle substituting 1 cup of white vinegar for the soap. Some glasses can become permanently etched if too much soap has previously been used.
- 💧 Residue and mineral build up can be cleaned from small appliances such as coffee makers by using a 2-1 solution of hot water and white vinegar.
- 💧 Limescale and hard water deposits which have built-up on faucets and plumbing fixtures prior to the installation of your new HALO water treatment system should be carefully removed with the help of products such as CLR® or Lime Away®. Lemi Shine® has also been reported to help remove mineral build up from dishwashers as well as from bathtubs, sinks and toilets.

Maintaining Your Bath & Shower Enclosures:

- 💧 Use CLR®, X-14®, Lemi Shine® or BIO-CLEAN® as directed to remove any existing mineral build-up from your bath tub, shower walls, shower basin and glass doors.
- 💧 Use a squeegee or wipe down shower doors and walls after each use to prevent spots caused by soap scum.
- 💧 Applying Turtle Wax® or Bio-Clean Superior Silicone Sealant® on clear glass doors, chrome, brass and dark colored shower tile will help to promote water sheeting and discourage soap scum build-up.
- 💧 HALO treated water contains almost no chlorine. This water it is more enjoyable to drink and to bathe in, but chlorine does help prevent mildew from developing. Proper ventilation and consistently wiping down the bath tub and shower enclosure after each use will keep your bathing area free of mildew.

Toilet Maintenance & Cleaning:

- 💧 Adding bleach to toilet bowl will help prevent mildew and bacteria. This is particularly important for newer low-flush toilets that do not fully flush away deposits.
- 💧 Infrequently used toilets, such as those located in vacation homes or in guest bathrooms, may be subject to rapid mineral build-up due to inactivity. Use a product such as CLR® to remove this mineral build-up.

H2 ZERO® Installation and Operation

ZERO ELECTRICITY • ZERO MAINTENANCE • ZERO BACKWASH

Whole House Filtration & Conditioning System

H2Z1054-CPI-100
H2Z1054-CPSM-100

H2Z1252-CPI-150
H2Z1252-CPSM-150

WARNING

Read this Manual BEFORE using this equipment. Failure to read and follow all safety and use information can result in death, serious personal injury, property damage, or damage to the equipment.

Keep this Manual for future reference.

WARNING

The HALO H2 ZERO® system should be installed ONLY by a licensed contractor.

FAILURE TO COMPLY WITH PROPER INSTALLATION AND MAINTENANCE INSTRUCTIONS COULD RESULT IN PRODUCT FAILURE WHICH CAN CAUSE PROPERTY DAMAGE, PERSONAL INJURY AND/OR DEATH. HALO Water Systems, LLC is not responsible for damages resulting from improper installation and/or maintenance. Local building or plumbing codes may require modifications to the information provided. You are required to consult the local building and plumbing codes prior to installation. If this information is not consistent with local building or plumbing codes, the local codes should be followed. Refer to the enclosed for operating parameters to ensure proper use with your water supply.

- Use only lead-free solder and flux for sweat-solder connections, as required by state, province and federal codes.
 - Handle all components of the system with care. Do not drop, drag or turn components upside down.
 - Be sure the floor under the system is clean, level and strong enough to support the unit.
 - Install the system in a protected area.
 - Do not attempt to treat water over 100°F with the system.
 - Always connect the system to the main water supply pipe before the water heater.
 - Do not expose the system to freezing temperatures. Water freezing in the system causes equipment damage.
 - Installation of a hose bib and a shut off (ball) valve is required downstream from the unit.
- * Fill the tank with water by SLOWLY opening the valve to half of the service position to prevent water hammer. Once the pressure has equalized in the tank the valve can be open full.. This is pertinent to the carbon, ion & scale media.

Introduction

The HALO residential H2 ZERO® systems provide protection from hardness related to scale formation throughout the plumbing system. The H2 ZERO® system can be installed at the point of entry to treat your entire home. These systems are designed to treat the domestic water used in a single family dwelling. For higher volume applications please contact your HALO representative.

H2 ZERO® prevents scale by transforming the normal dissolved hardness minerals into undissolved crystal microparticles. These crystals stay suspended in the water and have a reduced ability to react and attach to surfaces. Therefore, the problem of internal buildup of scale in pipes, water heaters and plumbing fixtures is greatly reduced.

Unlike softened water, H2 ZERO® treated water maintains the beneficial essential mineral content of your water.

Setup

- Unpack and check the system components for damage or missing parts and ensure both tank heads are tightened to the tanks.
- Do not install the system where it would block access to the water heater, main water shutoff, water meter, or electrical panels.
- Install the system in a place where water damage is least likely to occur if a leak develops.

H2 ZERO® Benefits

- **ZERO** maintenance required - no pre or post filter
- **ZERO** drain required
- **ZERO** waste, no backwash require
- Scale Prevention with **ZERO** chemicals
- 10 year warranty on carbon media, 5 year warranty on scale media
- Exempt from “softener bans” or restrictions
- KDF55 media economic benefit from longer lasting carbon
- NOT a softener

Bypass Valve and Connection Fittings

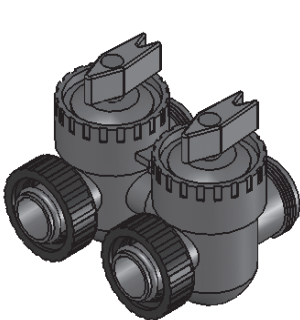

H-V3006
bypass assy.

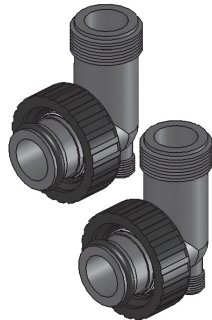

H-V3007
bypass assy.

Head →



Tank →



Equipment Specifications

HALO Water Systems, **H2 ZERO**® systems are completely loaded with media and ready to use. **ZERO** drain necessary, **ZERO** maintenance & **ZERO** electricity required

H2 ZERO® media needs to be protected from excess levels of certain metals that can easily coat the active surface, reducing its effectiveness over time. If the water supply is from a municipal supply or a private well, confirm that the levels of iron (Fe) and manganese (Mn) are less than 0.3 mg/L and 0.05 mg/L, respectively.

Please have a comprehensive well water sample taken before installation to ensure proper functionality. **DO NOT** install this system on a well without proper testing and recommendations from the manufacturer. This will void the warranty

WARNING

New Copper lines need to be passivated for a minimum of 4 weeks before placing scale media into service. System can run filtration only for 4 weeks before putting scale media into service. For applications with copper concentration greater than 1.3 ppm, please consult HALO Water Systems. To further minimize any problem with excess copper, avoid applying excessive flux on the inner surfaces of the pipe and use a low corrosivity water soluble flux listed under the ASTM B813 standard. This can be avoided by use of non-copper pipes.

No hydrogen sulfide can be present. Media will turn gray and unit will no longer be effective

Do not install system on microbiological unsafe water. This will void the warranty..

System can run filtration only for 4 weeks before putting scale media into service.

NOTICE: H2 ZERO® media does not reduce silica scaling. While silica tends to have a less significant effect on scale formation than other minerals, it can act as a binder that makes water spots and scale residue outside the plumbing system difficult to remove. This 20 ppm limitation is for aesthetic purposes.

Water known to have heavy loads of dirt and debris may require pre-filtration (Sediment Filter SC510) prior to **H2 ZERO**®.

Installation of a hose bib and a shut off (ball) valve is required downstream from the unit.

Feed Water Chemistry Requirements

| | |
|--------------------------|------------------------------------|
| Pressure | 15 psi to 90 (1.03 bar to 6.2 bar) |
| Temp. | 40° F to 100° F |
| Free Chlorine | <2ppm |
| pH..... | 6.5-8.5 |
| Iron (maximum)..... | 0.3 ppm |
| Manganese (maximum)..... | 0.05 ppm |
| Copper | 1.3 ppm |
| Maximum Hardness..... | 35GPG |

Installation and Start-up of Tank

**** Soak method is HALO's preferred method****

STEP 1: Carbon Tank Soak

The soak method allows the installer to clean any media fines out of the system at their facility before installing it at the customer's home. This is a cleaner method to ensure the best experience for the end user.

- Turn off the main water supply to the home and open an inside faucet to relieve any pressure within the plumbing system.
- **Place the bypass valve in the upflow service position.**
- Connect the cold water supply to the inlet of the **H2 ZERO**® system. NOTE: The **H2 ZERO**® system operates in the upflow mode which is opposite of a traditional filtration / softener.

Notice:

The system must be flushed to remove any media fines upon start up water will flow out of the outlet side of the Bypass Valve during this process. Be sure you perform this series of steps in a location suitable for water flow.

1. Connect inlet water supply to the inlet side of the bypass valve (FIG. 1) and hand tighten.
2. Fill the carbon tank full until water comes out of outlet side of the bypass valve.
3. Turn the water off.
5. Allow the carbon tank to soak for a minimum 48 hours prior to tank installation.



FIGURE 1

STEP 2: Carbon Tank Flush

IMPORTANT!

Do not perform the carbon tank flush until the carbon tank soak process is complete.

Notice:

Water will flow out of the bypass valve during this process. Be sure you perform this series of steps in a location suitable for water flow.

1. After the carbon has soaked for 48 hours, run water through the system to a drain to flush fines from the system.
3. Run water through the inlet side of the bypass valve for 30 minutes to expel the carbon fines. During this 30 minute process shut the water off every 5 minutes for 1 minute to agitate the media.
4. Once the rinse process has run for 30 minutes, run the water into a white cup or bucket. Ensure the water is clear and no fines are visible. If fines are noticed repeat the process until the water in the bucket is clear and free of fines.
5. Once water is clear and free of fines the system can be installed.

HALO SEDIMENT GUARD™

Included with the H2 Zero Ultimate system is a Sediment Guard™. The Sediment Guard™ must be installed AFTER the H2 Zero Ultimate™. The Sediment Guard acts as a polisher and filters sediment up to 5 microns. This is NOT an alternative to pre-soaking and flushing. Pre-soak and flushing are to be performed regardless of post filtration. See installation diagram.



Installation of a hose bib and a shut off (ball valve) is required downstream from the unit.

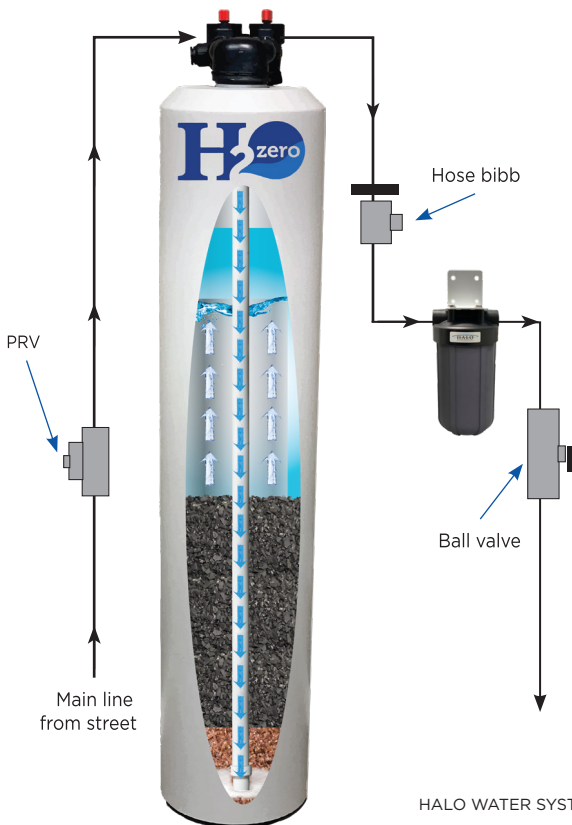

Onsite flush method.

- Plumb the system in the upflow configuration. A hose bib is required on the outlet of the system to rinse fines from the system. After the system is plumbed you will need to flush the system before running water into the residence.

- Remove washer from standard garden hose. (A)



- Locate flow washer from parts bag. (B)

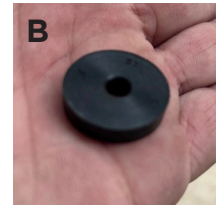

- Install flow washer from parts bag inside of hose connection. (C) The chamfered side of the flow washer should face towards the hose bib. (D)

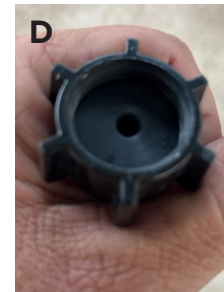

- Attach hose to bib to start the rinsing procedure.
- Flush system for 30 minutes in the upflow position out of the hose bib. Water will be a dark color. This is normal as it is washing media fines out during this procedure. Follow the below procedure for the rinsing instructions.
- Turn hose bib on full for 5 minutes.
- Turn hose bib off for 2 minutes allowing media to settle and agitate.
- Repeat the process 6 times.
- After system has been flushed 6 times, run water into a white bucket or cup and ensure water is clear and no fines are present. If water has a grayish look or fines are present repeat process until water is clear.

Conditioning - What to Expect & Best Practices

SPOTTING

Spotting is normal

Remember, the beneficial minerals have been conditioned and left in your water. These conditioned minerals will be easier to wipe up than unconditioned minerals, however if water is left to evaporate continuously on hard surfaces, scale will begin to form. The solution is to not allow water to evaporate on hard surfaces.

Glass shower doors

Years of scale formations on glass doors can etch the surface of the glass and cause soap and minerals to stick in those fissures. Using RainX® or a similar product in addition to a squeegee on shower doors can seal pores on the glass surface causing water to sheet. This greatly reduces spots and scale formation.

Dishwasher

In leaving the beneficial minerals in your water this may cause some occasional spotting on dishes and glassware. We recommend using Lemi-Shine® liquid rinse aid. This is an all natural product and will not leave any chemical residue behind.

Toilets

HALO Water is highly filtered to remove chemicals and disinfectants. When exposed the open atmosphere of a toilet bowl the water can grow mildew and bacterial. This is especially true with low flow toilets that do not fully flush away deposits and toilets that are unused for extended periods of time. Use a product such as CLR to remove deposits. Flush 'n Sparkle® is a recommended to introduce chlorine to ONLY the toilet bowl without the chlorine effecting the toilet gaskets, flapper or other components.

HARDNESS

Total Dissolved Solids

TDS is the measurement of all dissolved solids in your water, including but not limited to minerals. The conditioning process alters the scale forming minerals so they are no longer aggressive or harmful, but hardness tests cannot determine the difference between conditioned minerals and raw minerals and are ineffective in determining the performance of the HALO conditioning system. The TDS may increase slightly during the descaling process.

Boiling or Vaporizing Water

When boiling or vaporizing conditioned water and you may see white deposits form on the bottom of the pan or appliance. This is a normal reaction between conditioned minerals and extreme heat. If this causes a problem for humidifier or vaporizer use distilled water or contact the manufacturer for more information.

Slippery Water

The HALO Conditioning System uses no sodium or potassium. This is why you will not experience that slimy, slippery feeling on your skin and hair. The slippery feeling is caused by sodium. Instead the HALO Conditioning System provides you with bottled water quality water.



**ATTENTION INSTALLER:
LEAVE WITH CUSTOMER**



TEN YEAR, LIMITED LIFETIME WARRANTY

1. HALO will provide one replacement tank for any tank that fails due to a manufacturing defect.
2. HALO warrants that components for the equipment will be available for the lifetime of the system.
3. HALO will provide comparable components of our selection to replace any obsolete items.
4. HALO will, within 10 years from date of install repair or replace warranted defective control valve parts at no charge.
5. HALO will provide replacement carbon media at no charge (except freight and handling) for 10 years from the date of installation due to media failure.

CONDITIONS OF WARRANTY

1. The system must be installed and maintained according to local codes and secondarily in accordance with manufacturer's recommendations.
2. The system must be maintained with HALO approved replacement components.
3. Failures resulting from fire, freezing, neglect, accident, alteration, abuse, improper installation or acts of nature are not covered.
4. Water pressure must be regulated between 40 to 80 pounds per square inch working or static pressure. Pressure exceeding 80 pounds per square inch (psi) working or static pressure voids all warranty.
5. Pressures exceeding 120 pounds per square inch and vacuum in excess of 5"HG (17 Pa) voids warranty on tank.
6. Internal water temperature exceeding 100°F voids warranty.
7. Influent chlorine must not exceed 1 mg/L.
8. HALO does not warrant to perform, pay for, or finance any repairs and/or installations. The customer must contact the HALO representative and provide pictures of installation, serial and model number prior to any repairs or replacements.
9. If a H2 Zero system was purchased from a 3rd party, liquidator or by any means other than an authorized licensed wholesale distributor, the warranty is void.
10. The system must be properly installed by a licensed contractor.
11. Proper precautions must be taken when installing the system near objects that can be damaged by water. HALO Water Systems, LLC accepts no responsibility for water damage or loss of property due to water damage.

OBTAINING WARRANTY SERVICE

All returns must be accompanied by a "Return Merchandise Authorization" (RMA) form, the defective part(s), and original purchase receipt. HALO will, at our option, repair or provide replacement parts at no cost. HALO warranty does not include freight, handling, or on-site labor charges. HALO does not provide on-site service. You can contact HALO at (800) 591-0538.

LIMITATIONS AND EXCLUSIONS

This warranty is exclusive and in lieu of any other warranty expressed or implied, including but not limited to, any implied warranty of merchantability of fitness for a particular purpose. HALO shall not be liable for any loss or incidental or consequential damages resulting from the misuse or inability to use the equipment by the buyer or any user.



Bypassing System While on Vacation

When leaving the home:

- 1. Place the system in bypass**
Rotate the two red handles on the bypass valves 90 degrees in the clockwise direction. This bypasses the filter and restores city water to the home
- 2. Run the water inside the home**
Open the hot and cold faucets in the home for a couple of minutes to allow the unfiltered (chlorinated) water to reach every fixture. Leave the system in bypass.
- 3. Main Shutoff for Home**
If you wish to shut off water to the home, shut the water off at the main. Leave the system in bypass.

When returning to the home:

- 1. Return the system to the service position**
Rotate red handles counter clockwise.
- 2. Run the water inside the home**
Open the hot and cold faucets in the home for a couple of minutes to allow the unfiltered (chlorinated) water to flow out of the system, followed by freshly filtered water.



Service Position
UPflow tank.

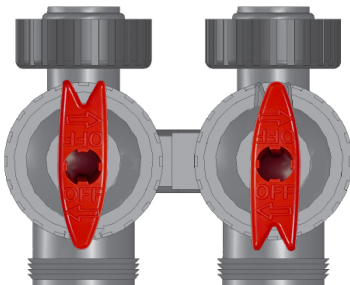

Bypass Position
UPflow tank.

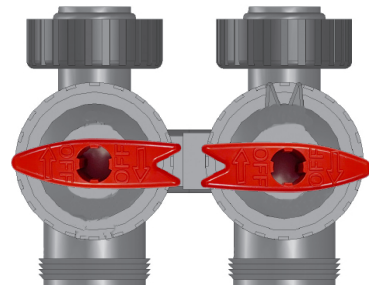

How much extra money are you currently spending by *not* using HALO?

Drinking Bottled Water?



\$3.00 per liter

Drinking • Bathing • Cooking
FILTERED & CONDITIONED



Protecting your
**FAMILY
 HOME
 & PLANET**

1000 liters a day for 10 years!

HALO Saves You Money!

| | Per Month | Per Year | 10 years |
|--|-----------|----------|----------|
| BOTTLED WATER | \$122 | \$1460 | \$10,000 |
| SHAMPOOS, SOAPS, ETC. (50%) | \$15 | \$180 | \$1,800 |
| HAIR COLOR & CONDITIONING (50%) | \$50 | \$600 | \$6,000 |
| REPLACING CLOTHES | \$25 | \$300 | \$3,000 |
| WATER TREATMENT (Exchange Tanks) | \$80 | \$960 | \$9,600 |

TOTAL COST OVER 10 YEARS, more than \$35,000

How about the big ticket items?

WATER HEATER *Replace every 12 years rather than every 6 years*

APPLIANCES *Dishwasher lasts 12 years rather than 8 years*

FIXTURE REPLACEMENT *One less faucet needing replacement every 10 years*

PINHOLE LEAKS *Chlorine and chloramines damage rubber seals and gaskets*

COPPER PIPING RE-ROUTE *Research has found a direct link between chlorine and copper corrosion*

TOTAL EXPECTED SAVINGS OVER 10 YEARS, more than \$42,600

Change your water. Change your life.



HALO FOR YOUR HAPPINESS.

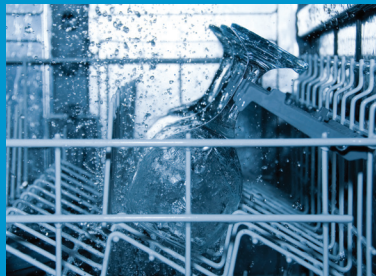

HALO TO KEEP YOUR APPLIANCES RUNNING RIGHT.



HALO FOR YOUR HEALTH.



HALO TO FEEL HEAVENLY.



HALO TO KEEP YOUR FIXTURES LOOKING FABULOUS.



HALO TO KEEP FABRICS FRESH.

WARNING: Do not use with water that is microbiological unsafe or of unknown quality without adequate disinfection before or after the system. Intended for use treatment of cold water only. Do not exceed 80 psi. Intended for residential use only.

NOTE: The HALO filtration systems are intended for treatment of potable water provided by municipal water providers. While the HALO Filtration Systems may be effective for treatment of well water it is vital that a well water quality analysis be provided for review and recommendation in to ensure that optimum results can be realized. Failure to provide a current well water report to HALO Water Systems for analysis and recommendation voids all warranties.