

HALO
ULTRA+^{PLUS}
REVERSE OSMOSIS SYSTEM



Smart Faucet
Blue light turns red
when it's time to
change the filters!

Water Saver





Industry leading 50% recovery rate!



Scan to learn more about
the HALO Ultra Plus

Installation & Instruction Manual

Initial Inspection..... 3
 Operation Parameters..... 4
 Plumbing Schematic..... 5
 Pre-Installation 6
 Faucet Installation 6-8
 Angle stop valve adaptor Installation..... 8-9
 HALO Leak Control Valve 9
 Drain Saddle Installation 10
 Tank Placement..... 10
 R.O. Unit Placement & Mounting..... 11
 Tubing Connections..... 11-13
 System Start-Up 14
 Flushing the R.O. System 14
 Filter Replacement 14-16
 Battery Replacement..... 17
 Troubleshooting 18-20
 Liability & Warranty..... 23

LEGEND	
	CAUTION / WARNING
	EYE PROTECTION
	ELECTRICAL WARNING
	FRAGILE

SYSTEM MUST BE INSTALLED BY A LICENSED CONTRACTOR



WARNING: READ ENTIRE MANUAL. FAILURE TO FOLLOW ALL GUIDES AND RULES COULD CAUSE PERSONAL INJURY OR PROPERTY DAMAGE.

Check with your state and/or local public works department for plumbing codes. You must follow their guides as you install the water filtration system.

NOTE: Failure to comply with these installation instructions will void the product warranty, and the installer will be responsible for any service, repair or damages caused thereby.



WARNING: DO NOT USE WITH WATER THAT IS MICROBIOLOGICALLY UNSAFE OR OF UNKNOWN QUALITY WITHOUT ADEQUATE DISINFECTION.

TOOLS & MATERIALS NEEDED FOR NORMAL INSTALLATION:

- Cordless Drill
- Carbide grinding burr
- 1/4" (6 mm) drill bit
- 7/16" (11 mm) drill bit
- 1/2" (13 mm) and 5/8" (16 mm) open-end wrenches (or adjustables)
- Phillips screwdriver
- Flashlight or droplight
- Teflon tape
- Protective eye wear (i.e. goggles)

REVERSE OSMOSIS SYSTEM INCLUDES

1. Reverse osmosis system
2. HALO - safety tray
3. HALO - leak detector
4. HALO - system protection valve*
5. Storage tank

* The system protection valve is a pressure limiting device that works under flow to help protect water filtration devices, water coolers, ice machines and other devices from the effects of water hammer. HALO system protection valve is NOT a pressure regulator. Static pressure will equalize with no flow through device.

PARTS

(already pre-installed to reverse osmosis system)

6. Smart faucet tells you when to change filters
7. 5 Micron sediment prefilter
8. 5 Micron carbon block prefilter
9. 50 Gallon per day membrane
10. Alkalinity pH booster filter
11. Inline flow restrictor
12. Connection tubing
13. Angle stop valve adaptor

ACCESSORIES (Included in installation packet)

14. Tank ball valve
15. Drain saddle

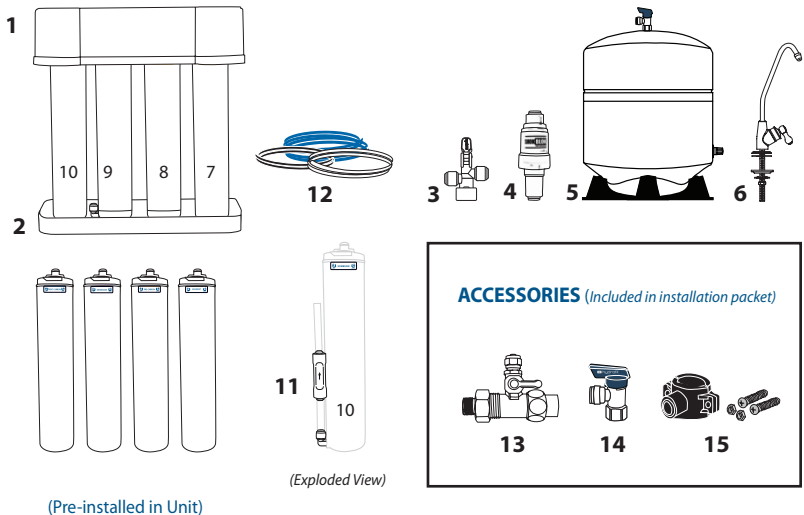



WARNING!! The following conditions for feed water supply must be met or warranty will be void.

1. Unit **MUST** be connected to a municipal or well water source that is treated and tested on a regular basis to insure water is microbiologically safe.
2. Operating temperatures:
Maximum: 100° F
Minimum: 33° F
3. Inlet Pressure **MUST NOT EXCEED** 80 PSI



CAUTION!! DO NOT ALLOW SYSTEM TO FREEZE. The membrane always contains water and will be destroyed if frozen.



WARNING!! DO NOT PLUMB SYSTEM TO HOT WATER. This will destroy the membrane and void the warranty.

4. Operating pressure:
Maximum: 80 PSI
Minimum: 40 PSI

This reverse osmosis system is designed to operate at a water pressure in the range of: 40 to 80 PSI.

- At pressures lower than this, the quantity as well as quality will be reduced.
- At higher pressure, severe damage to the system may result.

A pressure regulator **MUST** be installed on the feed water source, which reduces the water pressure coming into the system.

- Turbidity: <5 NTU
- pH: 4 - 11
- Recommended hardness **NOT TO EXCEED** 7 grains per gallon, or 120 PPM.

(If the hardness of your water is above 7 gpg, lime scale will build up rapidly on the membrane. Scale buildup will plug the membrane and make the system ineffective. We do not recommend these reverse osmosis systems be used with water in excess of 7 gpg hardness, unless the water is treated prior to the reverse osmosis HALO system).

- Sulfide, iron and manganese: <0.01 ppm
- Chlorine in water supply: <2 ppm
- Water supply pH limits: 4 - 11
- Recommended Total Dissolved Solids (TDS) **NOT TO EXCEED** 1,000 ppm.

If the water is out of any of the above parameters you may need to change filters more frequently.

SPECIFICATIONS FOR REVERSE OSMOSIS SYSTEM

- **System Dimensions:** 3.75" w x 4.75" d x 12.75" h
- **System Weight:** 6.1 lbs.
- **Tank Dimensions:** 11.3" d x 16.75" h
- **Tank Capacity:** 1.9–3.2 gal.
(Depending on water pressure)
- **Tank Weight:** Full - 40 lbs.
(Depending on water pressure)

PLUMBING SCHEMATIC FOR REVERSE OSMOSIS SYSTEM (HALO Ultra Plus Reverse Osmosis System)

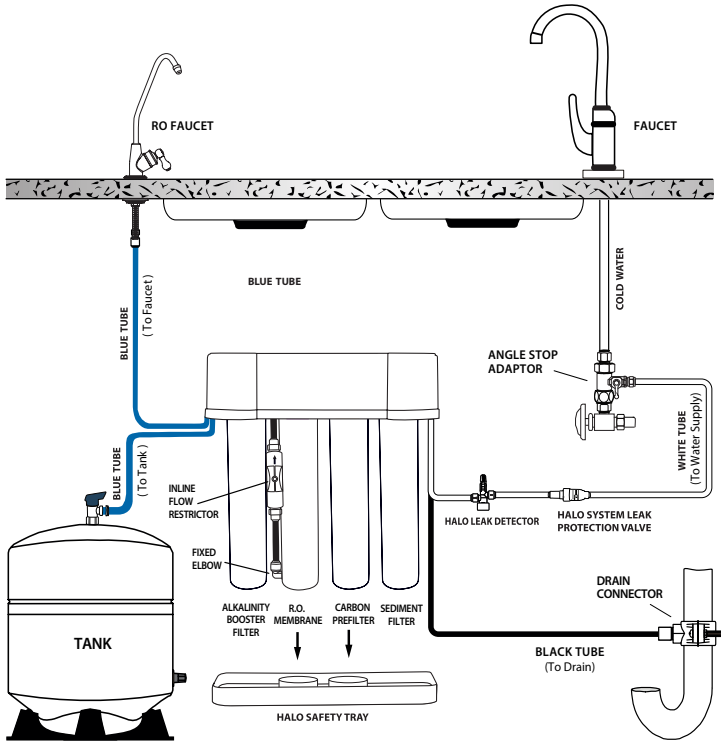

NOTE: The reverse osmosis system may be mounted to the side of the sink cabinet or set on the floor of the sink cabinet near the facet tube to maximize flow rate



IMPORTANT!! PLEASE READ THE FOLLOW AND SAVE THIS INSTRUCTION MANUAL.

1. PRE-INSTALLATION PROCEDURE

1. This unit includes a standard sink top faucet without an air-gap. In localities where plumbing codes require installation of an air-gap, contact your local distributor to obtain a code approved drain line adaptor.
2. The reverse osmosis system may be mounted to the side of the sink cabinet or set on the floor of the sink cabinet. It must be positioned to allow access for service and filter changes. The assembly should be relatively near the faucet to maximize flow rate. (See *DIAGRAM A* for a positioning example.)
3. The storage tank should be located where it can be removed if necessary. The storage tank may be placed in either the vertical or horizontal position without affecting the system performance. If there is insufficient space under the sink for placement, the tank may be located in an adjacent cupboard up to 50 ft. away. (See *DIAGRAM A* for a positioning example.)
4. The faucet should be positioned to allow a free flow pattern into the sink. It must be positioned to allow ready access to the mounting hardware under the sink. (See *DIAGRAM A* for a positioning example.)

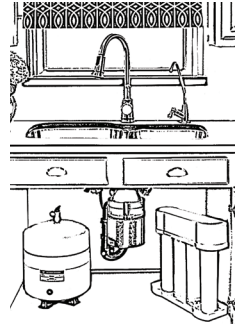

DIAGRAM A

2. SMART FAUCET INSTALLATION



CAUTION!! Extreme care must be taken in drilling the hole for the sink-top faucet. The surface material of most sinks is extremely hard and brittle and can be easily chipped or cracked. If you are uncomfortable performing the following procedure it is recommended that your experienced contractor be consulted for techniques, installation or other assistance. The system's manufacturer accepts no responsibility for sink top damage resulting from system installation. **EXTREME CAUTION SHOULD BE TAKEN WITH GRANITE, MARBLE AND LIKE MATERIAL.**



CAUTION!! Before grinding or drilling put on appropriate eye protection (i.e. goggles) to protect yourself from porcelain or metal chips.



CAUTION!! To avoid damaging the sink, consult a qualified contractor for drilling procedures. Special drill bits may be needed for porcelain or stainless steel.



WARNING: Many homes are electrically grounded through the plumbing. To protect yourself from serious injury or fatal shock, use a battery-powered hand drill only to make the hole. **DO NOT USE A CORDED ELECTRIC DRILL.**

1. **BEFORE DRILLING:** Check under the sink in the area that you plan to install the faucet and make sure that there is a flat surface to secure the mounting hardware. A flat space of approximately 2 inches in diameter is needed.

RECOMMENDATION: Before drilling or grinding mask off the immediate area surrounding the grinding/drilling location preferably with duct tape or if duct tape is unavailable masking tape may be used. This procedure should help prevent scratching of the sink surface.

2. REMOVE EVERYTHING FROM INSIDE THE SINK AND SURROUNDING AREA. Place paper towels in the sink to catch the shavings from the grinding and drilling.
3. Using a cordless drill with a carbide grinding burr, gently grind away enough porcelain or enamel to more than accommodate the 7/16" drill bit. Approximately the size of a dime. Enough surface material must be removed to expose the base metal.



CAUTION!! Porcelain or enamel must be completely removed in the drilling area to prevent immediate dulling of drill bit.

4. Remove everything from under the sink.
5. Place newspaper or paper towels directly under drilling location in order to catch the drill shavings.
6. Using the 1/4" (6 mm) drill bit, drill a centering or pilot hole in the center of the desired faucet location.

NOTE: this centering/pilot hole will make it easier for the 7/16" drill bit to cut through the sink. Operate the drill slowly and carefully— Especially when the drill bit is about to penetrate the metal. Otherwise, damage to sink may occur. Use lubricating oil to keep the drill bit cool while drilling.

7. Discard paper towels and newspaper used in sink and below sink. Be very careful not to drop any shavings in sink or on the floor as they will oxidize and stain surfaces very quickly.

HELPFUL HINT: If you notice any rust spots from dropped shavings you should be able to get rid of them by scrubbing them with a cleaning chemical.

8. Cover the drilled hole with your finger **BE VERY CAREFUL NOT TO CUT YOURSELF ON SHARP EDGES!** Rinse sink then scrub with cleaner to prevent any rusting from shavings and to prepare for faucet installation. Plug hole again while rinsing off cleaner. Hole must be plugged in order to avoid water dripping below into sink cabinet, which may cause damage.
9. Remove faucet from package.

For steps 10-13 refer to DIAGRAM B on page 8.

10. Slip the small, thin rubber gasket over the faucet shank. Next slip the chrome trim plate (escutcheon plate) over the faucet shank. Finally, slip the large, thin rubber gasket over the faucet shank.
11. Place the faucet shank complete with only hardware installed in step 11 through the drilled hole.
12. From under the sink slip the large, black plastic, locating washer over the faucet shank. Next, slip the lock washer over the faucet shank followed by the thin chrome nut.
13. While holding the faucet assembly above the sink tighten the chrome nut below the sink with an adjustable wrench. Tighten the chrome nut until the faucet assembly does not move.



CAUTION!! DO NOT OVERTIGHTEN THE CHROME NUT. Overtightening can cause damage to the sink or faucet assembly.

DIAGRAM B

For Faucet Installation
Steps 10-13 on page 7

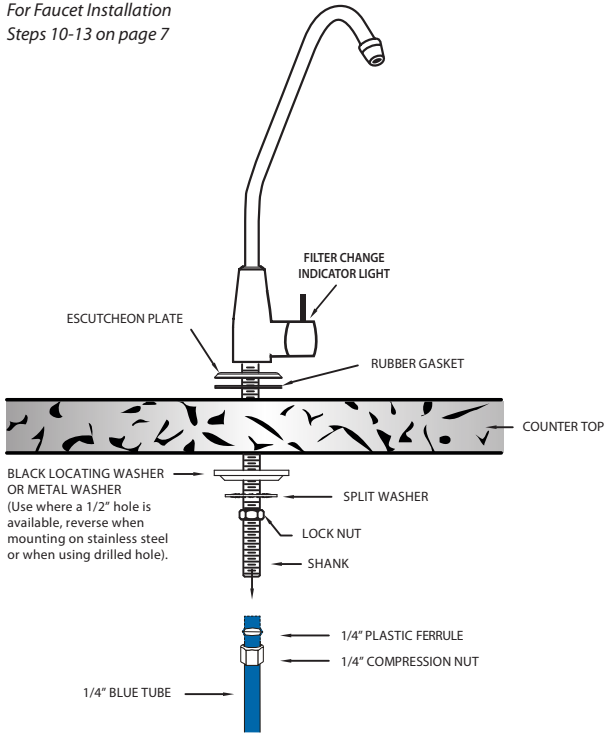

DIAGRAM C

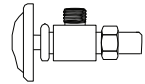

DIAGRAM D

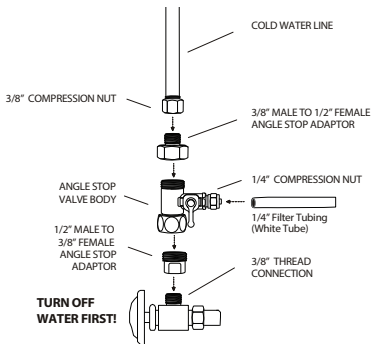
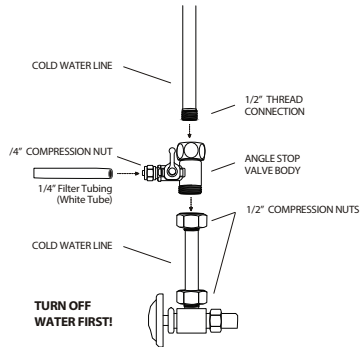

DIAGRAM E



4. INSTALLATION OF HALO LEAK CONTROL VALVE

(pre-installed)

HALO leak detector is a specially designed shut-off valve that turns off your water when a leak is detected. The HALO leak detector valve uses a compressed textile disc which expands upon water contact and pushes the valve lever up to the closed position to stop all water flow into the drinking water system.

NOTE: The HALO leak detector will not shut-off any water leak originating from the stop valve or any other connection which feeds water to it. HALO leak detector is designed to shut off water which is going into the drinking water system. (Please note that you can order replacement textile discs through you local contractor in case a disc accidentally becomes wet and expands.)



WARNING!!! The HALO leak detector valve **MUST** be installed to prevent any water leaks occurring from the drinking water system. Failure to install the HALO leak detector valve will automatically void the product warranty.

1. Locate compressed textile disc and set aside.
2. Place HALO leak detector into fixed position in tray and screw down. (If tray not use proceed to step 3).
3. Place HALO leak detector 2 inches from side wall of cabinet and 4 - 6 inches from the drinking water systems inlet side.
4. Affix the HALO leak detector with screws to the cabinet base (floor) with screws.
5. Lift HALO leak detector lever to off position.
6. Once final connection is made, remove lever pusher and insert textile disc with the pronounced part towards the bottom and reinsert lever pusher. Lower on/off lever to allow water to flow thru the system.

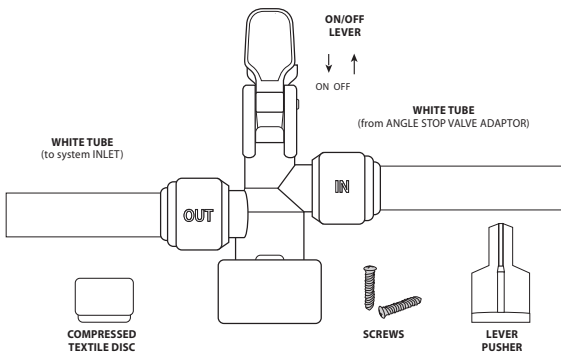

5. INSTALLATION OF DRAIN SADDLE

1. Open the package containing the drain saddle. (See *DIAGRAM F*)
2. Peel the protective film off of the sponge gasket. Apply gasket to inside of drain saddle, using care to align sponge gasket hole with drain port.
3. Position the drain saddle on the vertical or horizontal drainpipe from your sink. Position as far away from the garbage disposal as possible.

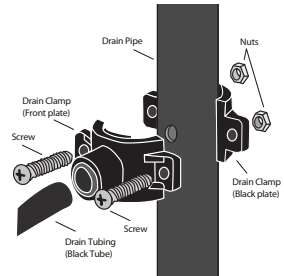

DIAGRAM F



DANGER!! The drain saddle **MUST** be installed on the side of the P-trap that goes to the sink drain!! If installed on the wrong side of the P-trap sewer gas could enter the unit and damage it.



CAUTION!! DO NOT INSTALL THE DRAIN LINE DOWNSTREAM OF A DISPOSER OR IN A HORIZONTAL PIPE.

4. Drill 1/4" hole into the drainpipe.



CAUTION!! Be very careful when drilling into drainpipe to not drill all the way through—stop after piercing the first wall of the pipe.

5. Mount the drain saddle. Align the drain saddle port with the 1/4" drilled hole using a small drill bit or other small straight object.
6. **GENTLY TIGHTEN** the two screws evenly on both sides of the clamp until the clamp is snug on the pipe.



CAUTION!! To avoid breaking plastic saddle or crushing drainpipe **DO NOT OVERTIGHTEN!**

6. TANK PLACEMENT

1. Wrap 4 to 5 wraps of teflon tape around the tank threads at the top of the tank.
2. Hand tighten the plastic shut off ball valve to tank stem.



CAUTION!! Hand tighten the valve only! **DO NOT OVERTIGHTEN!** If valve is overtightened it will crack and will leak.



IMPORTANT!! The tank pressure must be between 5-7 PSI when measured empty. This must be measured with a good dial or digital pressure gauge. A pop-up tire gauge will not give you an accurate reading. If you do not have access to a good gauge contact your local distributor to purchase one. If your tank pressure is above 7 PSI use the tank schrader valve to release pressure until there is between 5-7 PSI. If your tank pressure is below 5 PSI use a bicycle pump or compressed air to increase pressure to between 5-7 PSI.

3. The storage tank should be located where it can be removed if necessary. The storage tank may be placed in either the vertical or horizontal position without affecting the system performance. If there is insufficient space under the sink for placement, the tank may be located in an adjacent cupboard up to 50 ft. away.

7. R.O. UNIT PLACEMENT AND MOUNTING

1. Determine if mounting of the reverse osmosis system is necessary or desired. The system does not need to be mounted on the wall of the cabinet if there is room for it to sit on the floor. However, if it is mounted to the side of the cabinet it is easier to change the filters and does not take up floor space.

 **IMPORTANT!!** Be very careful not to kink any of the tubing on the reverse osmosis system. If tubing is kinked the tubing can rupture and leak.

2. Position the system on the wall at the desired mounting location 2 - 3 inches from base of cabinet. Using the bracket holes on the back of the bracket, mark on the wall with a pencil where the screws need to be inserted.
3. Set the system aside.
4. Screw the two (2) Phillip head screws (*supplied in the installation packet*) into the wall at the marked positions.

NOTE: Let the screw heads protrude from the wall enough to hang the reverse osmosis system safely.

6. Mount the reverse osmosis system onto the screws.

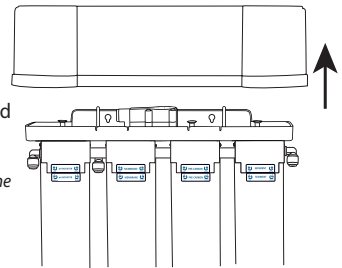

**LIFT COVER TO REVEAL
BRACKET HOLES**

8. TUBING CONNECTIONS

CONNECTING THE SYSTEM:

(WHITE TUBING - From system faucet port. This is from port labeled faucet)

1. Connect the white tubing to the faucet by slipping the 1/4" chrome nut over the tubing followed by the nylon ferrule.

NOTE: It is not necessary to have a 1/4" nylon insert in this line as it would restrict the flow through the faucet.

2. Push the white line all the way into the faucet stem and tighten the chrome nut. **DO NOT OVERTIGHTEN!!**

CONNECTING THE FEED WATER:

1. Locate the cold water angle stop, turn off cold water and open cold faucet line to de-pressurize.
2. Once depressurized remove 3/8" line from your "COLD" water angle stop, screw the angle stop valve adaptor onto the 3/8" angle stop hand tight.
3. Replace 3/8" line from above onto the angle stop valve adaptor male side and tighten accordingly.
4. Insert one end of the extra piece of white tubing into the inlet of the angle stop adaptor.

- From the inlet of the angle stop adaptor connect the white tubing to the HALO system protection valve and ensure the flow arrow is in the correct direction towards the unit.

CONNECTING THE TANK:

(WHITE TUBING - From system tank port)

Insert the white tubing from the RO system "Tank" Into the Quick Connect Tank Valve provided on top of the the tank.

CONNECTING THE DRAIN SADDLE:

(BLACK TUBING - From system drain port)

Insert the 1/4" black tubing into the Quick Connect Drain Saddle.

HOW TO MAKE QUICK CONNECT FITTINGS CONNECTIONS

1. CUT THE TUBING

Cut the tube cleanly and squarely. Ensure that the tube has a smooth outside diameter without any burrs, chamfers or score marks prior to inserting it into the fitting. Tubing that has not been cut properly can cause drips and leaks.

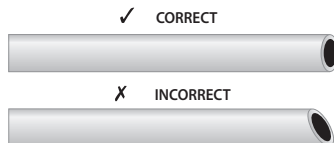

(Continues on page 13)

HOW TO MAKE QUICK CONNECT FITTINGS CONNECTIONS: (Continued)

2. INSERT TUBING

Push the tubing through the collet and o-rings until it bottoms out against the tube stop. The collet holds the tube in place and the o-ring provides a leak resistant seal. If you need to remove the tubing always re-cut before connecting tubing again. Scores on tubing can cause failure.

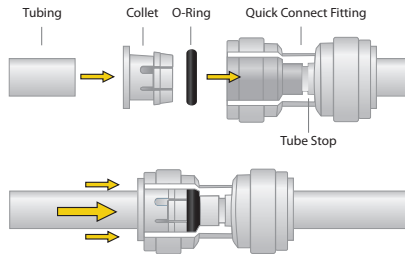

3. INSPECT AND TEST

Push and pull the tubing toward and away from the fitting to ensure that it has been installed properly. Test and inspect the installation for any leaks.

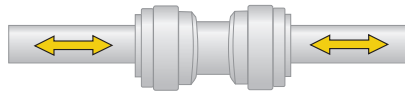

4. TUBE REMOVAL

Relieve pressure from the tubing and fitting. Push the collet flange against the fitting body while pulling the tubing away from the fitting to release it.

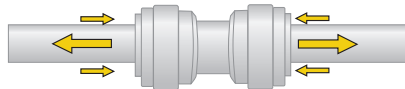

CAUTION!! IT IS RECOMMENDED THAT TUBING AND QUICK CONNECTION FITTINGS INSTALLATIONS ARE INSPECTED A MINIMUM OF ONCE PER YEAR AND PARTS REPLACED AS NEEDED.

9. SYSTEM START-UP

1. With all connections complete, turn on the cold water supply to the reverse osmosis system.



IMPORTANT!! The Reverse Osmosis Main Water Shut Off valve must be open. This means the white handle on the valve must be in the horizontal position.

2. Immediately check entire reverse osmosis system and tank for leaks. If you notice any leaks turn off cold water supply and fix the leak.



IMPORTANT!! Ensure that the ball valve on the storage tank is open. This means that the valve handle is in line with the white tubing.

3. Once no leaks have been determined. Lift the lever on the HALO leak detector valve and place compressed textile disc in holding cup and lower lever to allow water back into the system.

10. FLUSHING THE R.O. SYSTEM

1. The tank will fill in approximately 4-5 hours.
2. After the tank has filled, open the faucet and drain all the water from the tank until it is empty.
3. Within 2-3 hours after draining the first tank of water the water is ready for drinking.



CAUTION!! DO NOT USE FIRST TANK OF WATER FROM YOUR SYSTEM! The membrane contains a food grade preservative to protect it while in storage. This preservative is not harmful, however it does not have a pleasant taste. Therefore, do not use the first tank of water, which flushes the entire system removing any preservatives used during storage and preparing it to produce quality water.



CAUTION!! If installing the unit in new construction, ensure that house plumbing is flushed thoroughly before opening the water supply valve.



WARNING!! Discard all unused parts and packaging material after installation. Small parts remaining after the installation could be a choke hazard.

11. FILTER REPLACEMENT INSTRUCTIONS

FILTERS TWIST CLOCKWISE TO BE REMOVED

STEP 1

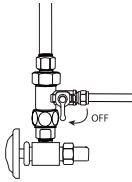

TURN WATER OFF

Shut-off the water supply and tank valve. Open the faucet and let water run approx. 1-2 minutes to depressurize the system.

Note: Place a towel or rag under the system to avoid water spills.

STEP 2

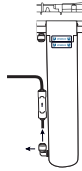

DISCONNECT

Remove black tubing with inline flow restrictor and fixed elbow from membrane.

Note: see section 8 on page 14 for tubing connection and disconnection instructions

STEP 3

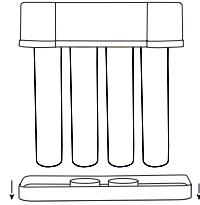

REMOVE TRAY

While the system is still mounted pull down on the safety tray and remove it.

CAUTION: Please be careful with tubing connections especially if system is not mounted.

STEP 4

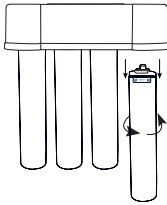

TWIST-OFF

Twist-off (towards the right) by hand each cartridge and pull down to remove.

STEP 5

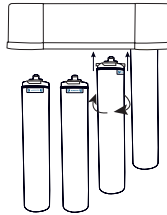

REPLACE FILTER

Insert and twist (towards the left) a new cartridge back on by hand. Cartridge labels must match and align.

Note: Make sure to discard all used cartridges according to your local law.

STEP 6



RECONNECT

Reinsert black tubing with inline flow restrictor and fixed elbow to membrane

(Flow arrow on flow restrictor MUST face up)

STEP 7

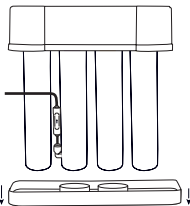

TRAY BACK ON

Insert safety tray back on by securing two of the middle cartridges down with hardware provided.

STEP 8

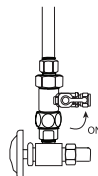

TURN WATER ON

Turn-on the water supply and tank valve (Turn handle to horizontal position).

STEP 9

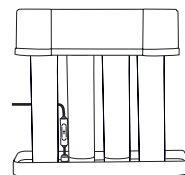

PURGE SYSTEM

See page 13 (Section 8 & 9) for instructions.

Note: Remove towel/rag once system has run and no leaks have been found.

REVERSE OSMOSIS SYSTEM REPLACEMENT FILTERS

4 stage filtration, 5 Stage quality.



STAGE 1

SEDIMENT

Replace Filter:
Every year

Five Micron Sediment Prefilter reduces dirt, sand, silt, sediment, and rust.



STAGE 2

PRE-CARBON

Replace Filter:
Every year

Five Micron Coconut Shell Carbon Block Prefilter reduces chloramines, chlorine taste, and odor.



STAGE 3

MEMBRANE

Replace Filter:
Every year

50 Gallon per day, semi-permeable reverse osmosis membrane for reduction of dissolved solids, including a wide range of toxic heavy metals, PFAS/PFOS, lead and pentavalent arsenic, giardia lamblia, cryptosporidium cysts, barium, cadmium, copper, hexavalent & trivalent chromium, cyst, fluoride, nitrate/nitrite, radium 226/228, selenium, TDS and turbidity.



STAGE 4

ALKALINITY BOOST FILTER Replace Filter:
Every year

Alkalinity pH booster filter adds minerals back to your water for healthy great tasting water.

NOTE: The life of the filters and membrane depend on the quality of water supplied to the reverse osmosis system.

It is recommended to replace the reverse osmosis system ever 10 years.

INSTALLATION INSTRUCTION

Important Notice Of Routine Maintenance And Care

- Occasional cleaning of aerator is recommended.
- Use of soapy water and a soft sponge or cloth is recommended.
- Avoid cleaning with chemicals, solvents, or harsh detergents. (THIS MAY SERIOUSLY HARM SURFACE AREA)
- If used with hard water or water with very high mineral content, it is absolutely necessary to clean and dry the faucet immediately after every use. (CALCIUM AND OTHER MINERALS COULD SERIOUSLY DAMAGE SURFACE AREA)
- Please wipe the canopy and keep your hands dry before installing or replacing the battery of the LED to prevent the LED circuit board from water or moisture damage.
- When installing with filtration system with carbon filters or changing carbon filters, it's suggested to flush the filtered tubes from the system before connecting with the faucet to prevent possible carbon dust contamination into faucet cartridge to cause leaking.



Battery Installation Steps

1 Install battery.

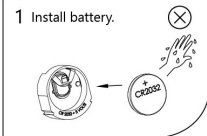

2 Reset: When installing or replacing battery, it will flash red light and follow by the blue light.

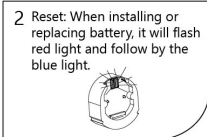

3 Install into faucet canopy. The slotted end must be oriented toward the faucet.

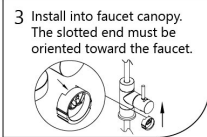

4 Blue light will flash when turning on the filtered water.

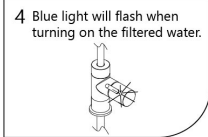

LED Indicator

1. Blue light will flash at operation after the battery is installed. It will flash red light when it has been activated over 12 months.
2. When it flashes a red light, it's time to change your filters and the battery at the same time.
3. The LED timer will start to count once the handle is fully open.

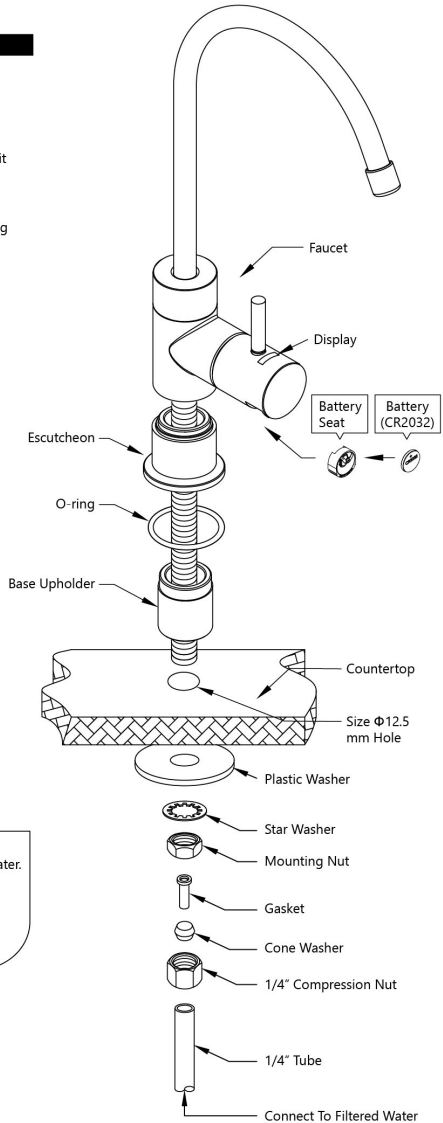

TROUBLESHOOTING

NOT ENOUGH WATER FROM HOLDING TANK

POSSIBLE	CAUSE / SOLUTION
Angle stop valve is plugged or closed.	Open valve or unclog.
Sediment/carbon prefilter or carbon post filter is clogged.	Replace filters.
Low incoming water pressure.	Incoming water pressure must be above 40 psi. Install a booster pump.
Reverse osmosis membrane is fouled.	Make sure incoming water pressure is within operating limits. Make sure drain line is not clogged (See High TDS). Correct cause of fouling and replace RO Membrane.
Air pressure in holding tank is incorrect.	Empty water from holding tank. Air pressure in valve stem should be between 5-7 PSI.
Air bladder in holding tank is ruptured.	Replace holding tank.
Holding tank valve is closed.	Open valve.
No water to drain. Drain flow restrictor is clogged.	Replace drain flow restrictor.
No water to drain.	Clear or replace drain line.
Check valve on ro membrane housing is stuck.	Replace check valve.
The automatic shut-off valve is malfunctioning.	Replace automatic shut-off valve.

LOW WATER PRESSURE FROM DISPENSING FAUCET

POSSIBLE	CAUSE / SOLUTION
Air pressure in holding tank is incorrect. This is the #1 reason for low flow from reverse osmosis faucet.	Open faucet and empty water from holding tank. Shut off feed water to system and remove holding tank from under sink. (The tank is easier to work on). Locate the air valve stem (just like on a car or bicycle tire) and add air. If there is still water in the tank, continue to add air until all the water is removed. Once all the water is removed, continue to add air and pressurize to 5-7 PSI. Re-install the tank under the sink, turn on the feed supply to the system and allow the tank to fill.
Holding tank valve is partially closed.	Open valve.
The faucet is out of adjustment or faulty.	Repair or replace faucet.
Heavy water use. Holding tank is empty.	Allow holding tank to refill.
Low water production.	See previous section on low quantity of water from holding tank.

TASTES AND ODORS IN PRODUCT WATER

POSSIBLE	CAUSE / SOLUTION
Filters are exhausted.	Replace filters.
There is foreign matter in holding tank.	Clean, flush and sanitize the holding tank. Replace filters.
Product water and drain water lines are reversed.	Correct plumbing.
Dissolved gases in feed water.	Pre-treat feed water to remove gases.
Increase in product water TDS.	High TDS in product water or drain water lines are reversed.

PRODUCT WATER IS HIGH IN TOTAL DISSOLVED SOLIDS (TDS)

POSSIBLE	CAUSE / SOLUTION
Clogged prefilter.	Replace filters.
Low incoming water pressure.	Incoming water pressure must be above 40 PSI. Install a booster pump.
Reverse osmosis membrane is not correctly sealed in membrane housing.	Check that ro membrane is correctly installed.
Reverse osmosis membrane is expended.	If membrane life is unusually short, find and correct the problem. Replace membrane and filters.
Product water and drain water lines are reversed.	Correct plumbing.
No water to drain. Drain flow restrictor is clogged.	Replace drain flow restrictor.
No water to drain.	Clear or replace drain line flow restrictor.
The automatic shut-off valve is not closing.	Repair or replace automatic shut-off valve.
The incoming feed water TDS has increased.	An increase in feed water TDS will also give an increase in product water TDS.

FAUCET LEAKS OR DRIPS

POSSIBLE	CAUSE / SOLUTION
Water leaks from faucet spout.	Adjust faucet by turning the tee bar located under the handle to provide a small amount of free play in the handle when shut off. Should this not work, repair or replace the faucet.
Leaks from beneath the handle.	Repair or replace the faucet.

NO WATER

POSSIBLE	CAUSE / SOLUTION
Water is shut off at stop valve	Open main stop valve. (See diagram on page 15)
HALO leak detector is set to off position	Make sure HALO leak detector main lever is in OPEN position. Lever should be lowered. (See diagram on page 10)

SERVICE RECORD

DATE	SEDIMENT FILTER (1 Year)	CARBON PRE-FILTER (1 Year)	MEMBRANE (1 Years)	ALKALINITY PH BOOSTER (1 Year)

NOTES

REGISTER YOUR WARRANTY

<https://halowater.com/activate-warranty/>

OR

SCAN CODE BELOW



LIABILITY



WARNING!!! The installer is responsible for any leaks resulting from installation of tubing or related fittings. **THE INSTALLER MUST CHECK OVER THE ENTIRE SYSTEM COMPLETELY WHILE UNDER PRESSURE TO ENSURE SYSTEM IS NOT LEAKING AND FUNCTIONING PROPERLY.** Liability resulting from failure to check for leaks under pressure is the sole responsibility of the installer.



Limited Two Year Warranty

1. Warranty Covers

The Reverse Osmosis Water Purification System is warranted to the original owner to be free of defects in material and workmanship from the date of manufacture for two years as follows:

- 1) The manufacture will replace the defective parts (excluding the replaceable filters) within two years at no charge.
- 2) The replaceable filters are warranted for defects in material and workmanship only. Service life of replaceable filter varies with local water and is thus not warranted. It is recommended to replace the reverse osmosis system every ten (10) years.

2. Warranty Does Not Cover

- 1) System must be maintained and serviced with manufacturer approved replacement parts. The performance and function of the RO system is directly related to the quality of the water being treated and the particular application in which it is used. Therefore, the manufacturer liability is limited to the cost of repair or replacement of any defective part and does not include incidental or consequential damages of any kind. This warranty gives you special legal rights and you may also have other rights which vary from state to state.
- 2) Systems must be installed and operated in accordance with manufacturer recommended procedures and guidelines.

3. Reverse Osmosis System warranty conditions

- 1) Warranty is void if product failure or damage result from freezing, neglect, misapplication, fouling with sediment or scale or failure to operate the system in accordance with the instructions contained in the owner's manual.
- 2) The following operating conditions must also be followed for this warranty to be valid.
- 3) Warranty void if system is not installed by a licensed contractor.

Operating pressure: 50-80 PSI

Operating temperature: 40-100 ° F

Hardness: <120 ppm (7gpg)

TDS: <1000 ppm

pH Range: 3-11

Iron: <0.3 ppm

4. Limitations and exclusions

The manufacturer will not be responsible for any implied warranties including those of merchant ability and fitness for a particular purpose. The manufacturer will not be responsible for any incidental or consequential damages including travel expense, telephone charges, loss of revenue, loss of time, inconvenience, loss of use of the equipment and damage caused by the equipment and its failure to function properly. If a HALO Reverse Osmosis system was purchased from a 3rd party, liquidator or by any means other than an authorized licensed wholesale distributor, the warranty is void. This warranty sets forth all of manufacturer's responsibilities regarding this equipment. Failure to provide a current well water report to HALO Water Systems for analysis and recommendation voids all warranties.

HALO
ULTRA **PLUS**
REVERSE OSMOSIS SYSTEM

Change your water. Change your life.

www.HALOWater.com • 800-591-0538